

DISPLAY PRODUCTS













CUSTOM PRINTING & DISPLAY HARDWARE

Display Products Catalog Ordering Instructions:

1. View catalog, select item or items.
2. Write down page number, name, and code number of product.
3. Select Printing Services button on our online ordering home page.
4. Select the category "It's Complicated Custom Request."
5. Include the product information from the catalog in the special instructions box.
6. Submit the order or request a quote (send email with quote number if you request a quote).

If you have any questions, please call Printing Services @ 837-2322 or email us @ PrintingServices@MissouriState.edu

CONTENTS

- 2-3  **ADVERTISING FLAGS**
- 4-5  **TABLE COVERS**
- 6-7  **TENTS**
- 8  **EXPANDABLE WALL DISPLAY**
- 9  **TENSION FABRIC DISPLAYS**
- 10  **CUSTOM BANNERS AND BACKDROPS**
- 11  **CUSTOM SIZED FLAGS AND FENCE GRAPHICS**
- 12-13  **POP-UP DISPLAYS**
- 14-15  **SEG POP-UP AND FRAME DISPLAYS**
- 16-23  **SINGLE SIDED RETRACTABLE DISPLAYS**
- 24-25  **DOUBLE SIDED RETRACTABLE DISPLAYS**
- 26-27  **OUTDOOR DISPLAYS**
- 28  **TENSION DISPLAYS**





ADVERTISING FLAGS

- Full-color dye-sublimation printing
- 110g knitted polyester fabric (single-sided flags)
- 100D polyester fabric (double-sided flags)
- Direct print process provides excellent color saturation to back side of fabric
- Double-sided flags are tri-layered & include a blockout center
- Features reinforced pole sleeve
- Printed flag includes bungee cord to attach to pole base



Durable fiberglass-graphite composite pole set with carrying case included



Coated-steel rotating spike with stainless steel bearings for in-ground application



Heavy-duty X-base for indoor or flat surface environments



Water bag to provide additional weight (for use with X-base)

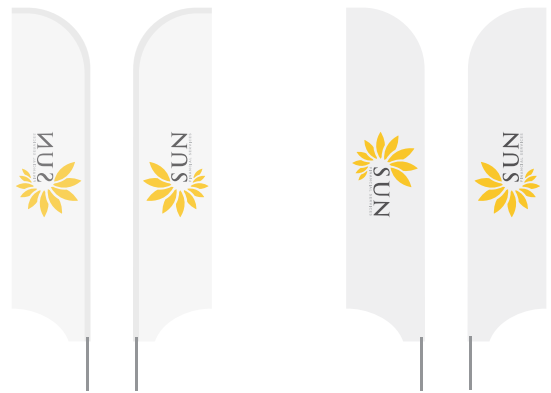

Single-sided

Double-sided

Single-sided printing is visible on both sides (mirror image on the back). Double-sided printing ensures that the graphics on both sides read properly.

Code	Description
ACCESSORIES	
FLGPBS	Pole for Small Blade/Teardrop Flag
FLGPBM	Pole for Medium Blade/Teardrop Flag
FLGPBL	Pole for Large Blade/Teardrop Flag
FLGPRS	Pole for Small Rectangle Flag
FLGPRM	Pole for Medium Rectangle Flag
FLGPRL	Pole for Large Rectangle Flag
FLGGS	Rotating Ground Spike
FLGXB	X-Base
FLGWB	Water Bag (for X-Base)

SIZE COMPARISON CHART

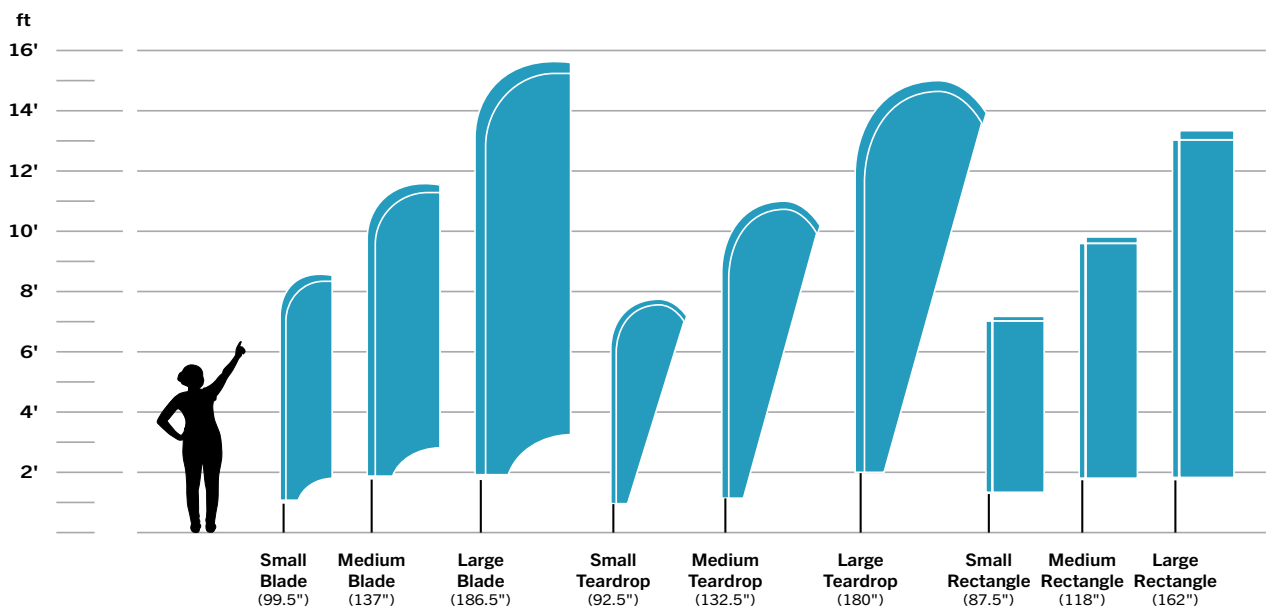

BLADE FLAG STYLE CHOICES



CONCAVE



CONVEX



ANGLED



STRAIGHT

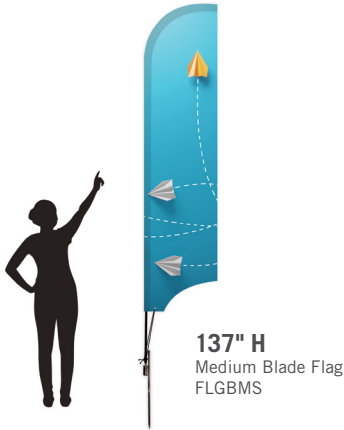

Code	Description	Viewable Area
ADVERTISING FLAGS - BLADE		
FLGBSS	Small Single-Sided	29" W × 86" H
FLGBSD	Small Double-Sided	29" W × 86" H
<i>The overall display height for this model (Base + Pole + Flag) is 99.5"</i>		
FLGBMS	Medium Single-Sided	32" W × 113.5" H
FLGBMD	Medium Double-Sided	32" W × 113.5" H
<i>The overall display height for this model (Base + Pole + Flag) is 137"</i>		
FLGBLS	Large Single-Sided	36" W × 164.5" H
FLGBLD	Large Double-Sided	36" W × 164.5" H
<i>The overall display height for this model (Base + Pole + Flag) is 186.5"</i>		



Code	Description	Viewable Area
ADVERTISING FLAGS - TEARDROP		
FLGTSS	Small Single-Sided	35" W × 79" H
FLGTSD	Small Double-Sided	35" W × 79" H
<i>The overall display height for this model (Base + Pole + Flag) is 92.5"</i>		
FLGTMS	Medium Single-Sided	38" W × 119" H
FLGTMD	Medium Double-Sided	38" W × 119" H
<i>The overall display height for this model (Base + Pole + Flag) is 132.5"</i>		
FLGTLS	Large Single-Sided	40" W × 158" H
FLGTLD	Large Double-Sided	40" W × 158" H
<i>The overall display height for this model (Base + Pole + Flag) is 180"</i>		

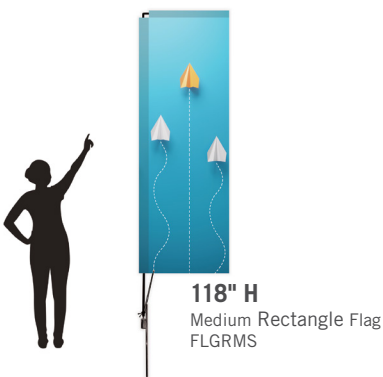

Code	Description	Viewable Area
ADVERTISING FLAGS - RECTANGLE		
FLGRSS	Small Single-Sided	32" W × 68.5" H
FLGRSD	Small Double-Sided	32" W × 68.5" H
<i>The overall display height for this model (Base + Pole + Flag) is 87.5"</i>		
FLGRMS	Medium Single-Sided	32" W × 98" H
FLGRMD	Medium Double-Sided	32" W × 98" H
<i>The overall display height for this model (Base + Pole + Flag) is 118"</i>		
FLGRLS	Large Single-Sided	32" W × 140" H
FLGRLD	Large Double-Sided	32" W × 140" H
<i>The overall display height for this model (Base + Pole + Flag) is 162"</i>		

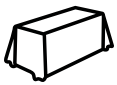

CUSTOM PRINTED TABLE COVERS

- Full-color dye-sublimation printing
- 250g soft knit polyester fabric (Drape, Fitted & Runners)
- 300D Wrinkle resistant and flame retardant polyester (Drape, Fitted & Runners)
- 180g elastic polyester fabric (Stretch)
- Machine washable

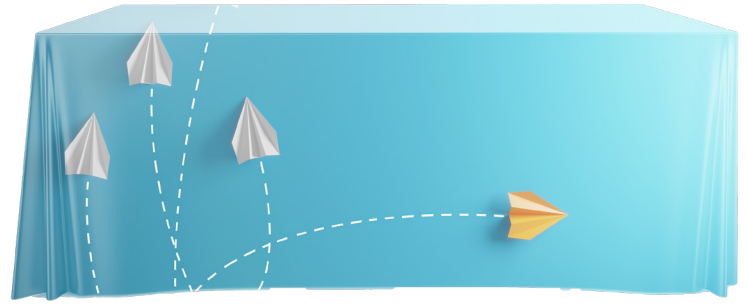

DRAPE

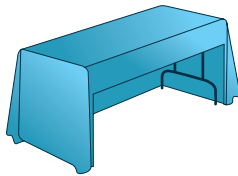

3-Sided Drape (Back View)

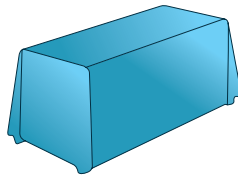

3-Sided Drape (Front View)

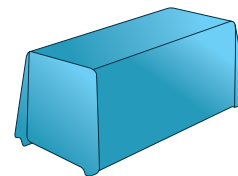

4-Sided Drape (Back View)

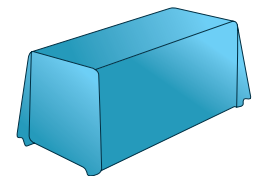

4-Sided Drape (Front View)

Code	Description	Table Dimensions
DRAPE		
TCVD43	4' Table 3-Sided - Drape	48" W x 30" D x 30" H
TCVD44	4' Table 4-Sided - Drape	48" W x 30" D x 30" H
TCVD63	6' Table 3-Sided - Drape	72" W x 30" D x 30" H
TCVD64	6' Table 4-Sided - Drape	72" W x 30" D x 30" H
TCVD83	8' Table 3-Sided - Drape	96" W x 30" D x 30" H
TCVD84	8' Table 4-Sided - Drape	96" W x 30" D x 30" H

Code	Description	Table Dimensions
CONVERTIBLE DRAPE		
	<i>Converts quickly and easily to fit both 6' & 8' tables. Velcro® tabs make conversion simple.</i>	
TCVDC684	6' - 8' Convertible 4-Sided Drape	72" - 96" W x 30" D x 30" H

FITTED

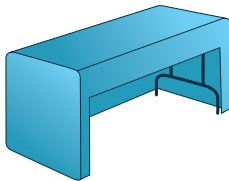

3-Sided Fitted (Back View)

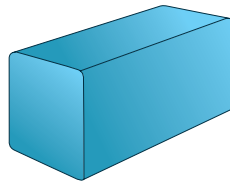

3-Sided Fitted (Front View)

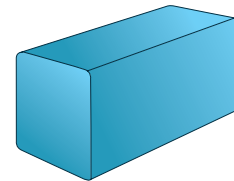

4-Sided Fitted (Back View)

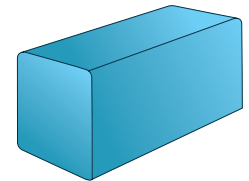

4-Sided Fitted (Front View)

Code	Description	Table Dimensions
FITTED		
TCVF43	4' Table 3-Sided - Fitted	48" W x 30" D x 30" H
TCVF44	4' Table 4-Sided - Fitted	48" W x 30" D x 30" H
TCVF63	6' Table 3-Sided - Fitted	72" W x 30" D x 30" H
TCVF64	6' Table 4-Sided - Fitted	72" W x 30" D x 30" H
TCVF83	8' Table 3-Sided - Fitted	96" W x 30" D x 30" H
TCVF84	8' Table 4-Sided - Fitted	96" W x 30" D x 30" H



STRETCH

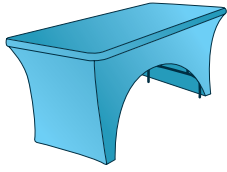

3-Sided Stretch (Back View)

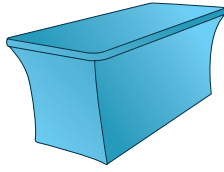

3-Sided Stretch (Front View)

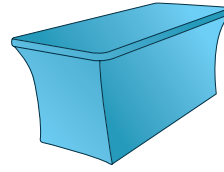

4-Sided Stretch (Back View)

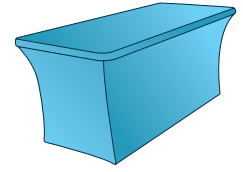

4-Sided Stretch (Front View)

Code	Description	Table Dimensions
STRETCH		
TCVS43	4' Table 3-Sided - Stretch	48" W × 30" D × 30" H
TCVS44	4' Table 4-Sided - Stretch	48" W × 30" D × 30" H
TCVS63	6' Table 3-Sided - Stretch	72" W × 30" D × 30" H
TCVS64	6' Table 4-Sided - Stretch	72" W × 30" D × 30" H
TCVS83	8' Table 3-Sided - Stretch	96" W × 30" D × 30" H
TCVS84	8' Table 4-Sided - Stretch	96" W × 30" D × 30" H

TABLE RUNNERS & BLANK DRAPE COVERS

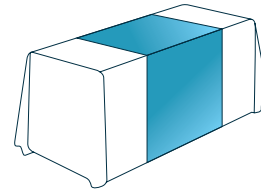
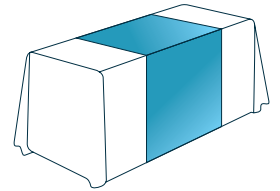
36" Table Runner (Back View)
w/ Blank White Drape Cover36" Table Runner (Front View)
w/ Blank White Drape Cover

Code	Description	Dimensions
TABLE RUNNERS		
TR2488	24" Table Runner	24" W × 88" L
TR3088	30" Table Runner	30" W × 88" L
TR3688	36" Table Runner	36" W × 88" L
TR4288	42" Table Runner	42" W × 88" L
TR4888	48" Table Runner	48" W × 88" L

Additional custom sizes available. Call for details

Code	Description	Table Dimensions
BLANK DRAPE COVERS		
TCVDBW64	White, 6' Table 4-Sided - Drape	72" W × 30" D × 30" H
TCVDBB64	Black, 6' Table 4-Sided - Drape	72" W × 30" D × 30" H
TCVDBW84	White, 8' Table 4-Sided - Drape	96" W × 30" D × 30" H
TCVDBB84	Black, 8' Table 4-Sided - Drape	96" W × 30" D × 30" H

Additional colors available. Material is 7 ounce polyester fabric. Call for details.



ADVERTISING TENTS

- Full-color dye-sublimation printing
- 600D polyester fabric
- Features weather-proofed canopy seams
- Lightweight and easy to transport, yet incredibly strong
- Thick-walled, 40mm hexagonal, aluminum tubing structure
- Durable nylon components
- Spike and rope kit included
- Basic carrying case included (10' x 10' model)
- Premium wheeled carrying case included (10' x 15' & 10' x 20' models)

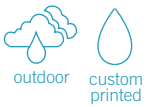
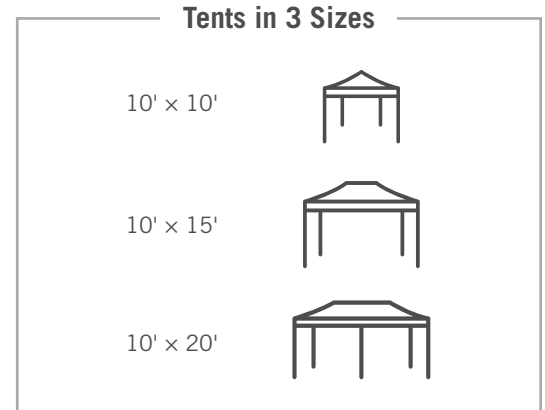

Code	Description	Viewable Area
ADVERTISING TENTS		
TNT10	10' x 10' Tent	120" W x 120" D x 97.5 - 132" H
TNT15	10' x 15' Tent	120" W x 180" D x 97.5 - 132" H
TNT20	10' x 20' Tent	120" W x 240" D x 97.5 - 132" H

Code	Description	Viewable Area
ADVERTISING TENT BLANK CANOPY (White), 10' x 10'		
TNT10BWCAN	Canopy	120" W x 120" D

Code	Description
ACCESSORIES	
TNTSAR	Spike & Rope Kit
TNT10WC	Premium Wheeled Carrying Case for 10' x 10' Tent



blank tent canopy



spike & rope kit



premium wheeled carrying case



ADVERTISING TENT WALLS



Full Wall



Full Wall with Zipper



Half Wall



Protective Screen

Code	Description	Viewable Area
10' x 10' ADVERTISING TENT WALLS		
TNT10FWS	Full Wall, Single-Sided	116.5" W x 82" H
TNT10FWD	Full Wall, Double-Sided	116.5" W x 82" H
TNT10ZWS	Full Wall with Zipper, Single-Sided	116.5" W x 82" H
TNT10ZWD	Full Wall with Zipper, Double-Sided	116.5" W x 82" H
TNT10HWS	Half Wall, Single-Sided	118.5" W x 38" H
TNT10HWD	Half Wall, Double-Sided	118.5" W x 38" H
TNT10HPS	Half Wall, Transparent PVC Film	118.5" W x 38" H
TNT10FPS	Full Wall, Transparent PVC Film	118.5" W x 82" H
10' x 15' ADVERTISING TENT WALLS		
TNT15FWS	Full Wall, Single-Sided	174" W x 82" H
TNT15FWD	Full Wall, Double-Sided	174" W x 82" H
TNT15ZWS	Full Wall with Zipper, Single-Sided	174" W x 82" H
TNT15ZWD	Full Wall with Zipper, Double-Sided	174" W x 82" H
10' x 20' ADVERTISING TENT WALLS		
TNT20FWS	Full Wall, Single-Sided	233" W x 82" H
TNT20FWD	Full Wall, Double-Sided	233" W x 82" H
TNT20ZWS	Full Wall with Zipper, Single-Sided	233" W x 82" H
TNT20ZWD	Full Wall with Zipper, Double-Sided	233" W x 82" H

Code	Description
ACCESSORIES	
TNT10BAR	10' Half Wall Bar Kit (Required for the Half Wall option)

Half wall option is available for the 10' x 10' sides of all three tent models.

(Required for the Half Wall Option)

Half Wall Bar Kit

TNT10BAR





EXPANDABLE WALL DISPLAY

- Commonly referred to as a "step and repeat" display
- Full-color dye-sublimation printing
- 250g soft knit polyester fabric (blockout version available by request)
- Finish: **Black**
- Adjustable height and width
- Robust 1½" diameter telescoping poles
- Carrying case included



LED light kit (Optional)

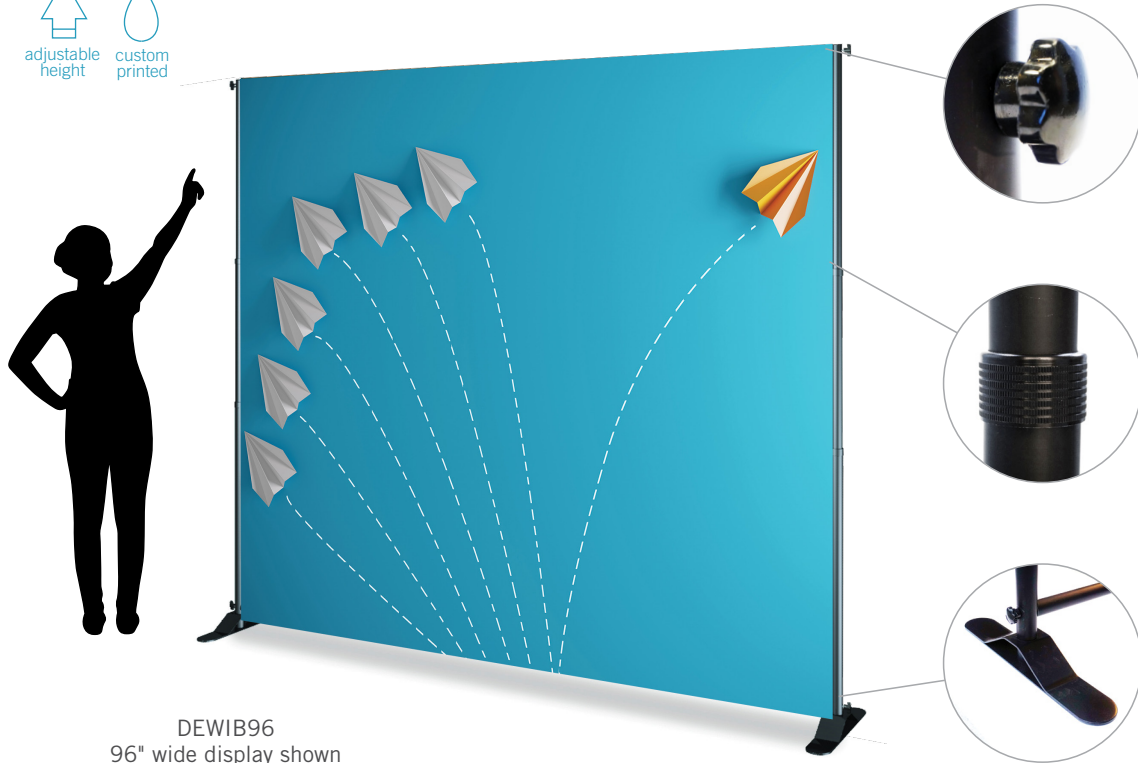
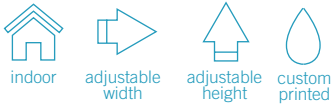

Code	Description	Viewable Area
96" WIDE EXPANDABLE WALL		
DEWIB96	Black	42" – 96" H x 60" – 120" W
140" WIDE EXPANDABLE WALL		
DEWIB140	Black	58" – 140" H x 42" – 140" W

Code	Description
ACCESSORIES	
DPULBL	LED UL-Listed Light Kit <i>Includes tube clamp adapter</i>



TENSION FABRIC DISPLAYS

- Simple pull-over "pillowcase" graphic installation
- Full-color dye-sublimation printing
- 240g soft knit polyester fabric (blockout version available by request)
- Single or Double-sided graphics available
- Robust 1 1/4" diameter tube structure
- Heavy-duty steel base for stability
- Varying sizes/options available
- Carrying case included



LED light kit (Optional)



90" H
63" H
36" H

Each Tension Fabric banner display has 3 height options. Simply remove the unnecessary vertical sections for desired display height.



DSTS36
36" wide display shown

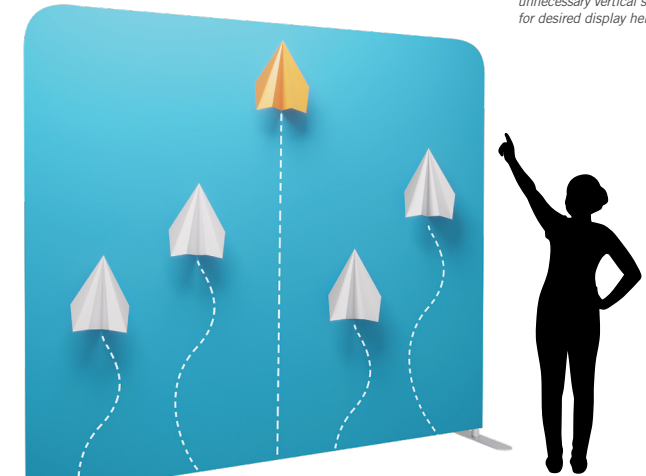

DSTW96
96" wide display shown



Code	Description	Viewable Area
TENSION FABRIC DISPLAYS		
DSTS24	Black	24" W x 90" H
DSTS36	Black	36" W x 90" H
DSTS48	Black	48" W x 90" H
DSTS60	Black	60" W x 90" H
DSTW96	Silver	96" W x 90" H
DSTW115	Silver	115" W x 90" H

Code	Description
ACCESSORIES	
DPULBL	LED UL-Listed Light Kit <i>Includes tube clamp adapter</i>

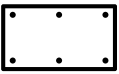

CUSTOM BANNERS & BACKDROPS

- Full-color dye-sublimation printing
- 250g soft knit polyester fabric (blockout available by request)
- Multiple finishing options available (pole pocket, grommet, hemmed edge, and Velcro®)
- Double-sided option available
- Any custom size can be produced

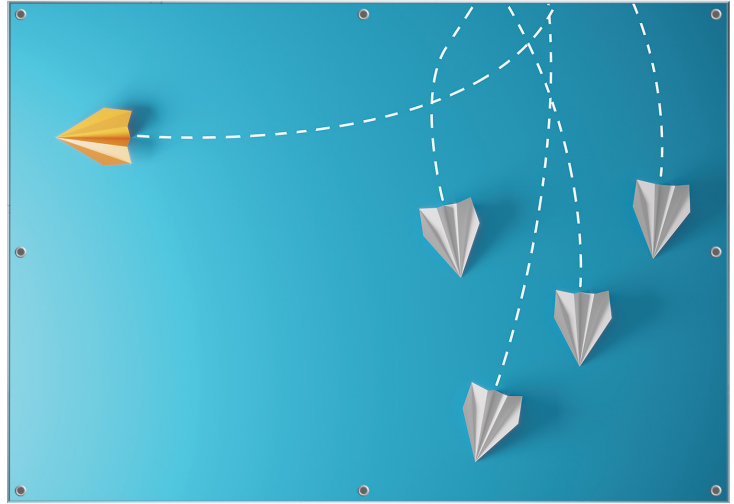

Code	Description	Viewable Area
CUSTOM BACKDROPS		
DSUBBD	Backdrops	Custom



CUSTOM SIZED FLAGS

- Full-color dye-sublimation printing
- 110g knitted polyester fabric (single-sided flags)
- 100D polyester fabric (double-sided flags)
- Direct print process provides excellent color saturation to back side of fabric
- Double-sided flags are tri-layered & include a blockout center
- Multiple finishing options available
- Golf and car flags available

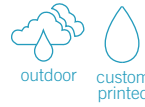
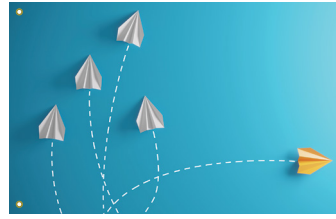

FINISHING OPTIONS

Custom sized flags are hemmed on four sides with a standard grommet strip on the left side. By request, optional finishing is available.

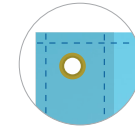

hem & standard grommet



reinforced grommet strip (black or white only)

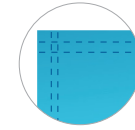

hem

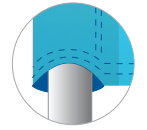

pole pocket

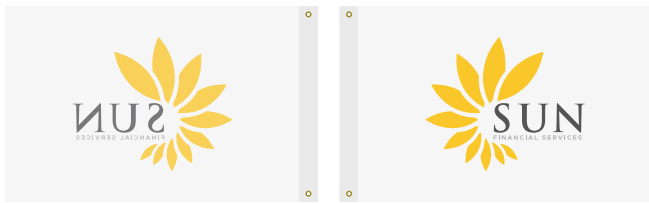

SINGLE SIDED

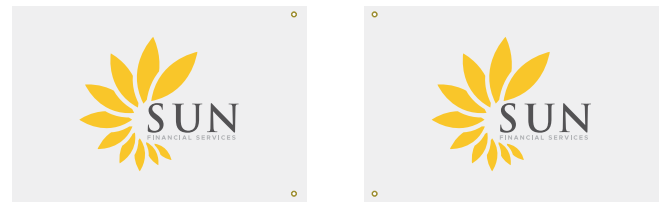

DOUBLE SIDED

Single-sided printing is visible on both sides (mirror image on the back).
Double-sided printing ensures that the graphics on both sides read properly.

Code	Description	Viewable Area
CUSTOM SIZED FLAGS		
FLG2436	2' x 3' Flag	24" H x 36" W
FLG3660	3' x 5' Flag	36" H x 60" W
FLG3672	3' x 6' Flag	36" H x 72" W
FLG4872	4' x 6' Flag	48" H x 72" W
FLG6096	5' x 8' Flag	60" H x 96" W
FLG72120	6' x 10' Flag	72" H x 120" W

Standard industry sizes are listed above. Manufacturing is not limited to these sizes; any custom size can be produced.

FENCE GRAPHICS

- Full-color dye-sublimation printing
- 110g knitted polyester fabric
- Direct print process provides excellent color saturation to back side of fabric
- Hem & grommet finishing
- Any custom size can be produced

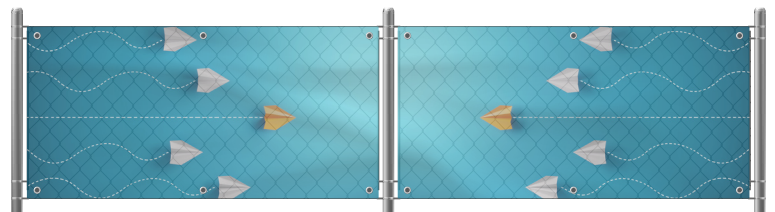
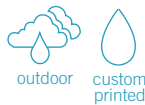

Code	Description	Viewable Area
FENCE GRAPHICS		
DSUBF	Fence Graphics	Custom

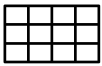

WALL DISPLAYS

- Full-color dye-sublimation printing
- 280g blackout soft knit polyester fabric
- Lightweight, easy to transport
- Strong aluminum frame design
- Pre-attached Velcro®
- Leveling Feet
- Carrying case included

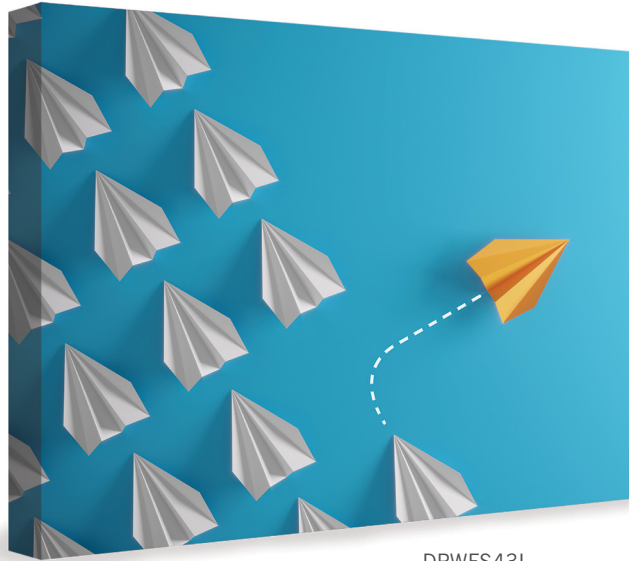

DPWFS43L
120" wide display shown



LED light kit
(Optional)



DPWFS13L
1 X 3 (Straight)
30" W x 90" H



DPWFS33L
3 X 3 (Straight)
90" W x 90" H

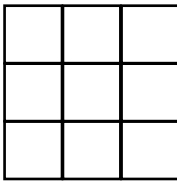

DPWFS43L or DPWFC43L
4 X 3 (Straight or Curved)
120" W x 90" H

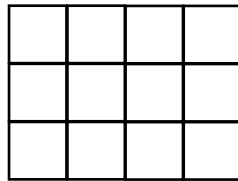

DPWFS53L
5 X 3 (Straight)
150" W x 90" H

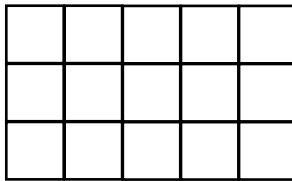

Code	Description	Viewable Area
BACK WALL DISPLAYS		
DPWFS13L	Straight	30" W x 90" H
DPWFS33L	Straight	90" W x 90" H
DPWFS43L	Straight	120" W x 90" H
DPWFC43L	Curved	120" W x 90" H
DPWFS53L	Straight	150" W x 90" H

Code	Description
ACCESSORIES	
DPULBL	LED UL-Listed Light Kit

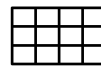

TABLETOP DISPLAYS

DPWFS11L
1 X 1 (Straight)
30" W x 30" H



DPWFS21L
2 X 1 (Straight)
60" W x 30" H

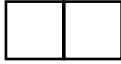

DPWFS22L or DPWFC22L
2 X 2 (Straight or Curved)
60" W x 60" H

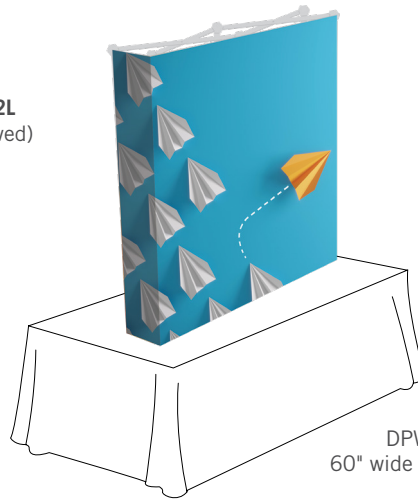
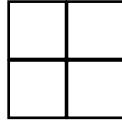

LED light kit
(Optional)



DPWFS22L
60" wide display shown

Code	Description	Viewable Area
TABLETOP DISPLAYS		
DPWFS11L	Straight	30" W x 30" H
DPWFS21L	Straight	60" W x 30" H
DPWFS22L	Straight	60" W x 60" H
DPWFC22L	Curved	60" W x 60" H

Code	Description
ACCESSORIES	
DPULBL	LED UL-Listed Light Kit

POP-UP COUNTER

- Full-color dye-sublimation printing
- 280g blockout soft knit polyester fabric
- Lightweight, easy to transport
- Strong aluminum square-frame design
- Pre-attached Velcro®
- Wood-grain textured laminate counter & shelves
- Leveling Feet
- Carrying case included



Code	Description	Viewable Area
POP-UP COUNTER		
DPCFS39	Pop-Up Counter	67" W x 38" H



SILICONE EDGED GRAPHICS (SEG) WALL DISPLAYS

- Full-color dye-sublimation printing
- 260g blockout soft knit polyester fabric
- Patented frame design
- Quick setup
- No tools required for setup
- Wheeled carrying case included



stabilizer foot (use is optional)

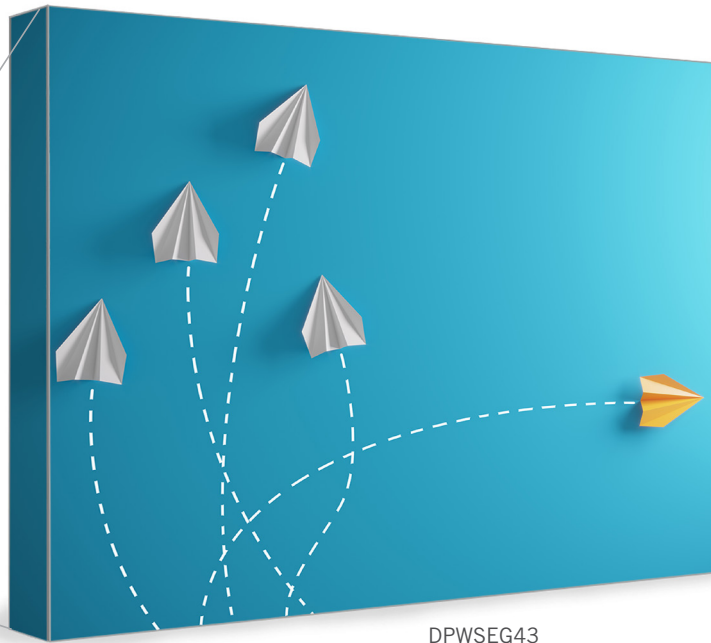

DPWSEG43
120" wide display shown



LED light kit (Optional)

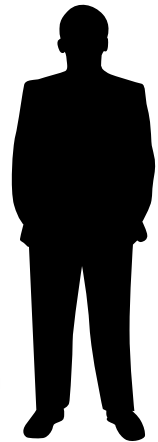

DPWSEG33
3 X 3 (Straight)
90" W x 90" H

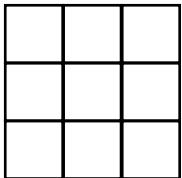

DPWSEG43
4 X 3 (Straight)
120" W x 90" H

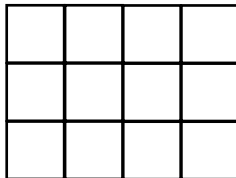

Code	Description	Viewable Area
SEG WALL DISPLAYS		
DPWSEG33	Straight	90" W x 90" H
DPWSEG43	Straight	120" W x 90" H

Code	Description
ACCESSORIES	
DPULBL	LED UL-Listed Light Kit

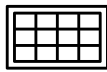

SILICONE EDGED GRAPHICS (SEG) & FRAMES

- Full-color dye-sublimation printing
- 230g soft knit polyester fabric (blockout version available by request)
- Easy to assemble, sleek and lightweight aluminum frames
- No experience required to change graphics
- Every SEG display is made-to-order
- Finish: **Silver**

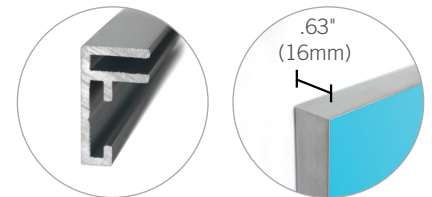
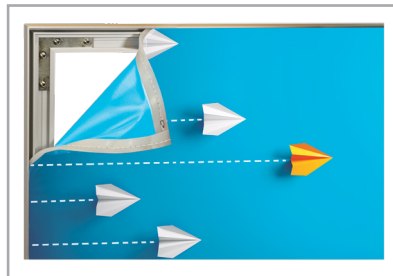

without corner bracket



with corner bracket



corner bracket



straight bracket



wall mounting bracket

Code	Description
ACCESSORIES	
SEGCB	Corner Bracket
SEGSB	Straight Bracket
SEGWB	Wall Mounting Bracket

Hybrid frame design allows frame pieces to be attached directly to a wall or built as a frame using the optional corner and straight brackets. Frame size and mounting preferences determine the quantity of wall mounting brackets needed for each frame. Manufacturing size is not limited, any custom size can be produced.



THE CLASSIC

- Finish: **Silver**
- Graphic is held with top clamp rail and bottom adhesive leader film
- Features fixed-height 3-part pole
- Padded carrying case included

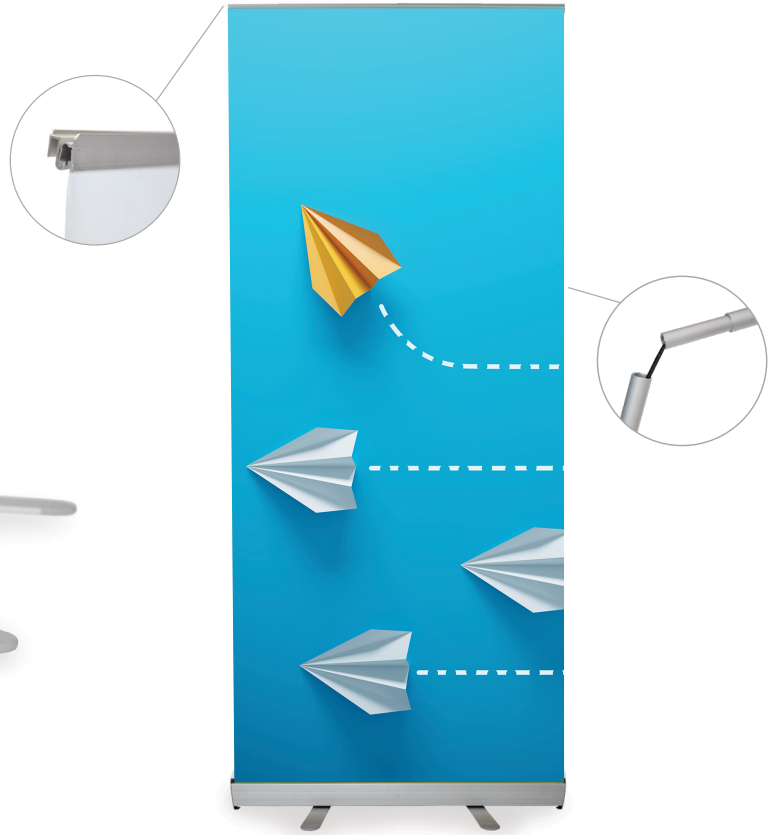
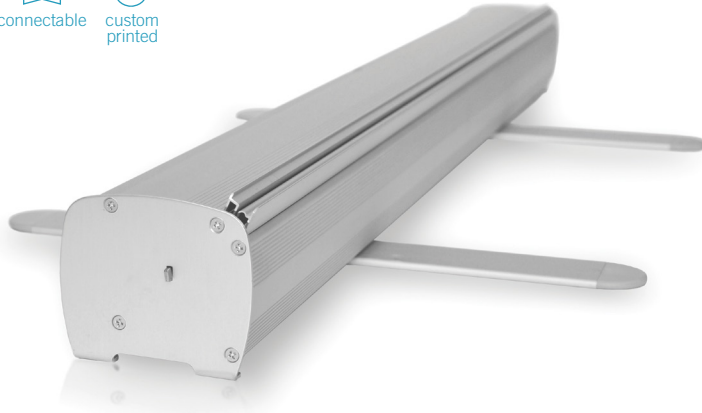

Code	Description	Viewable Area
THE CLASSIC		
DRCS34	Silver	33.5" W x 78.75" H

Code	Description
ACCESSORIES	
DRCMCS	Magnetic Top Clamp Connector
DRULSL	Universal (UL Listed) LED Light Kit

(Optional)
Magnetic Top Clamp Connector
DRCMCS

Build a display wall using multiple stands and magnetic connectors

(Optional)
Magnetic Top Clamp Connector
DRCMCS

(Optional)
Universal (UL Listed) LED Light Kit
DRULSL

UL listed



THE RELIANT

- Heavy gauge aluminum construction
- Polished chrome end plates and feet
- Finish: **Silver** or **Black**
- Graphic is held with top clamp rail and bottom adhesive leader film
- Features fixed-height 2-part pole (12" model only)
- Features adjustable-height pole (15" model only)
- Features fixed-height 4-part pole (24" model only)
- Features fixed-height 3-part pole (34", 39", 48" and 60" models)
- Padded carrying case included

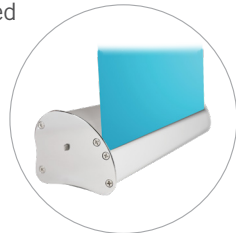

12" & 15" tabletop model*

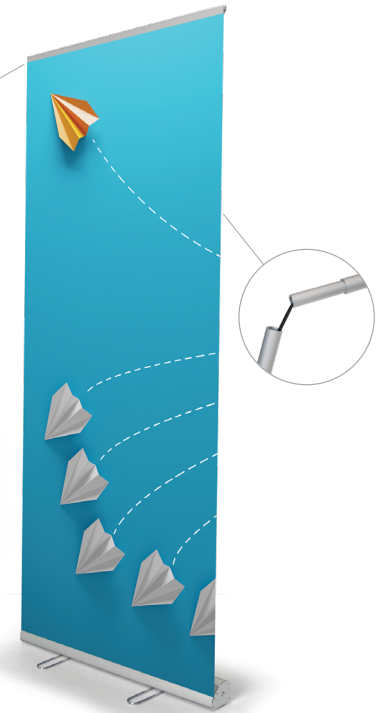

Code	Description	Viewable Area
THE RELIANT		
DRRS12	Silver	11.75" W × 20" H
DRRS15	Silver	15" W × 27.25" – 35.5" H
DRRB15	Black	15" W × 27.25" – 35.5" H
DRRS24	Silver	23.5" W × 78" H
DRRS34	Silver	33.5" W × 78" H
DRRB34	Black	33.5" W × 78" H
DRRS39	Silver	39.3" W × 78" H
DRRS48	Silver	47.25" W × 78" H
DRRS60	Silver	59" W × 78" H

Code	Description
ACCESSORIES	
DRAMCS	Magnetic Top Clamp Connector
DRULSL	Universal (UL Listed) LED Light Kit

*12" & 15" tabletop models do not have support feet. 24" & 15" has 1 support foot other sizes feature 2 support feet. The 48" and 60" Reliant models feature 2 fixed-height poles for added stability.

(Optional)

Magnetic Top Clamp Connector

DRAMCS

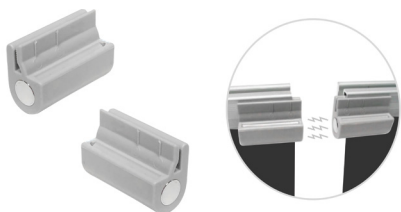

(Optional)

Universal (UL Listed) LED Light Kit

DRULSL





THE FALCON II

- Sleek profile base
- Finish: **Silver**
- Graphic is held with top clamp rail and bottom adhesive leader film
- Features adjustable-height pole
- Padded carrying case included

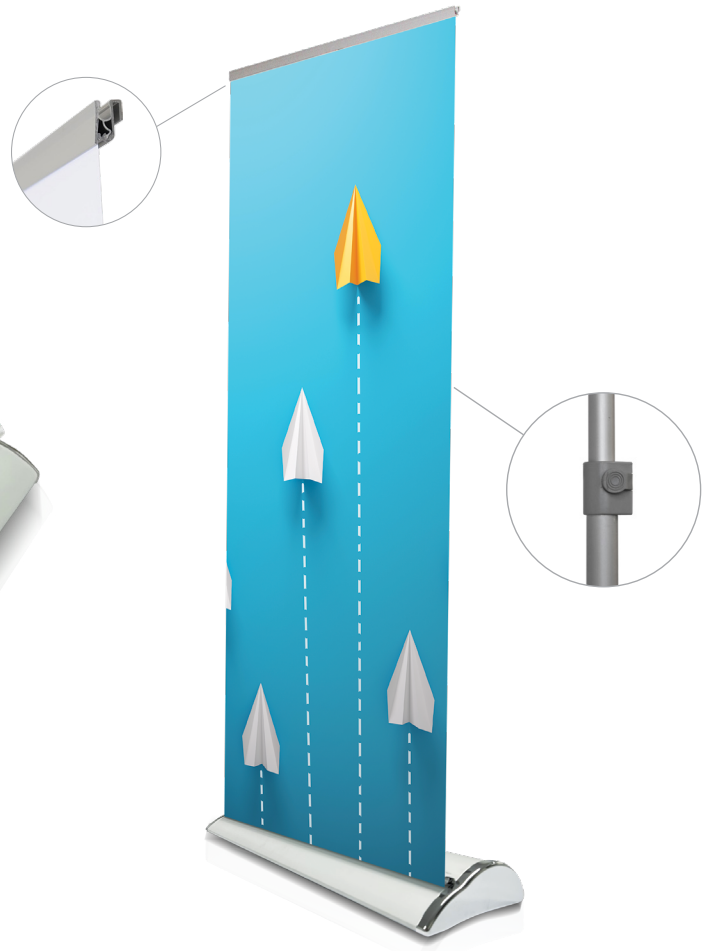
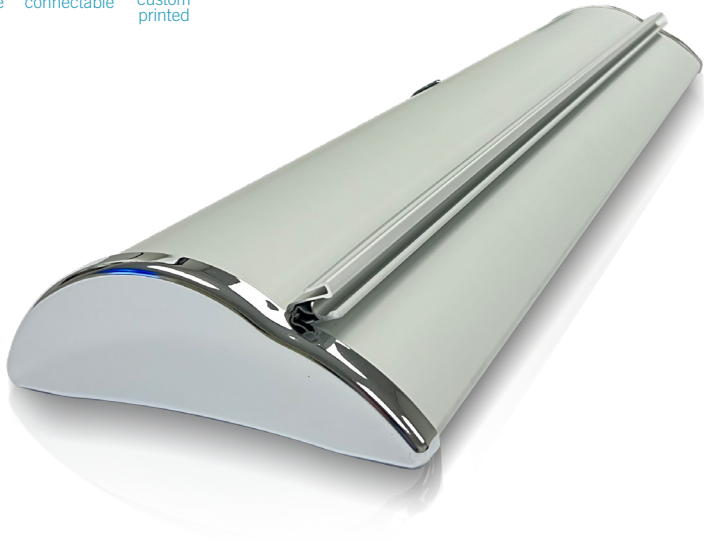
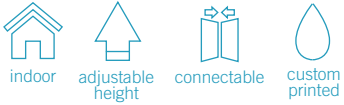

Code	Description	Viewable Area
THE GUARDIAN		
DRFS34	Silver	33.5" W x 61" – 84" H

Code	Description
ACCESSORIES	
DRAMCS	Magnetic Top Clamp Connector
DRULSL	Universal (UL Listed) LED Light Kit

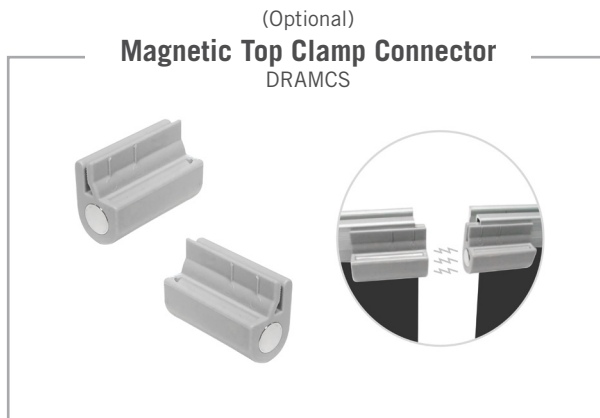



THE GUARDIAN

- Simple modern base
- Polished chrome end plates
- Finish: **Silver**
- Graphic is held with top clamp rail and bottom adhesive leader film
- Features adjustable-height pole
- Padded carrying case included

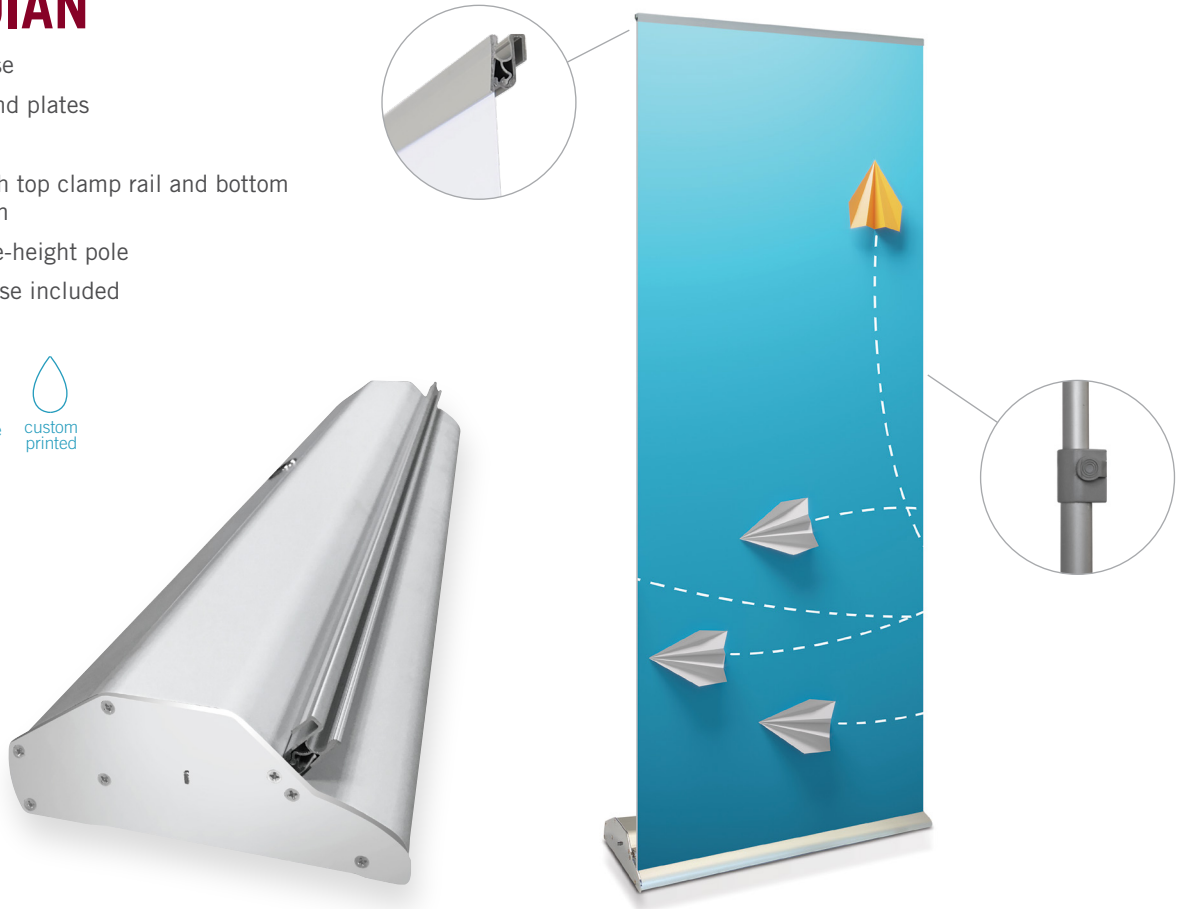

Code	Description	Viewable Area
THE GUARDIAN		
DRGS34	Silver	33.5" W x 61" – 84" H

Code	Description
ACCESSORIES	
DRAMCS	Magnetic Top Clamp Connector
DRULSL	Universal (UL Listed) LED Light Kit

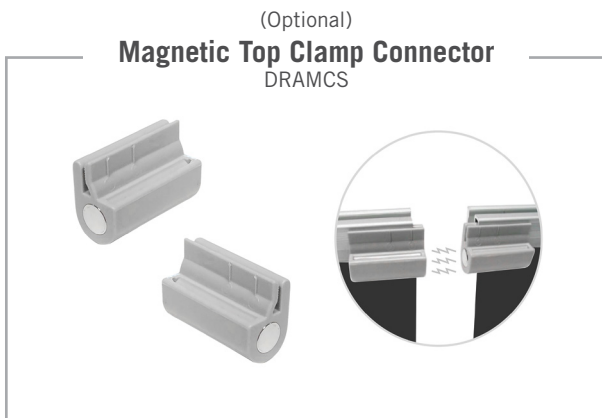



THE VENTURE

- Stylish, contoured base
- Adjustable height (allows for use as tabletop display)
- Finish: **Silver** or **Black**
- Graphic is held with top clamp rail and bottom adhesive leader film
- Features adjustable-height pole
- Padded carrying case included

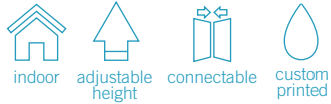

15" tabletop model



Code	Description	Viewable Area
THE VENTURE		
DRVS15	Silver	15" W x 19.75" – 36" H
DRVS24	Silver	23.5" W x 67" – 84" H
DRVS34	Silver	33.5" W x 33" – 84" H
DRVB34	Black	33.5" W x 33" – 84" H
DRVS36	Silver	36" W x 33" – 84" H
DRVS48	Silver	47.25" W x 33" – 84" H
DRVS60	Silver	59" W x 33" – 84" H

Code	Description
ACCESSORIES	
DRAMCS	Magnetic Top Clamp Connector
DRULSL	Universal (UL Listed) LED Light Kit

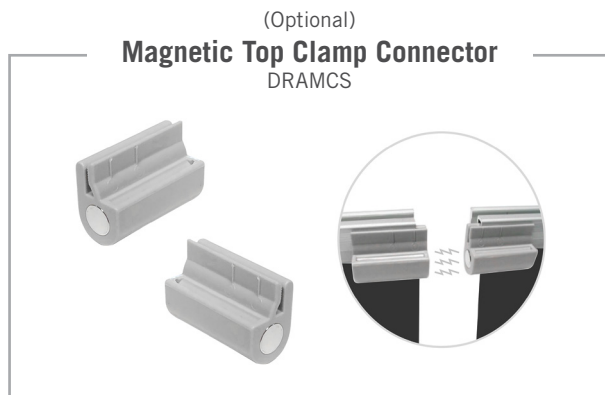



THE MAJESTIC

- Interchangeable graphic drum
- Adjustable height (allows for use as tabletop display)
- Finish: **Silver**
- Graphic is held with top clamp rail and bottom clamp drum
- Features adjustable-height pole
- Padded carrying case included

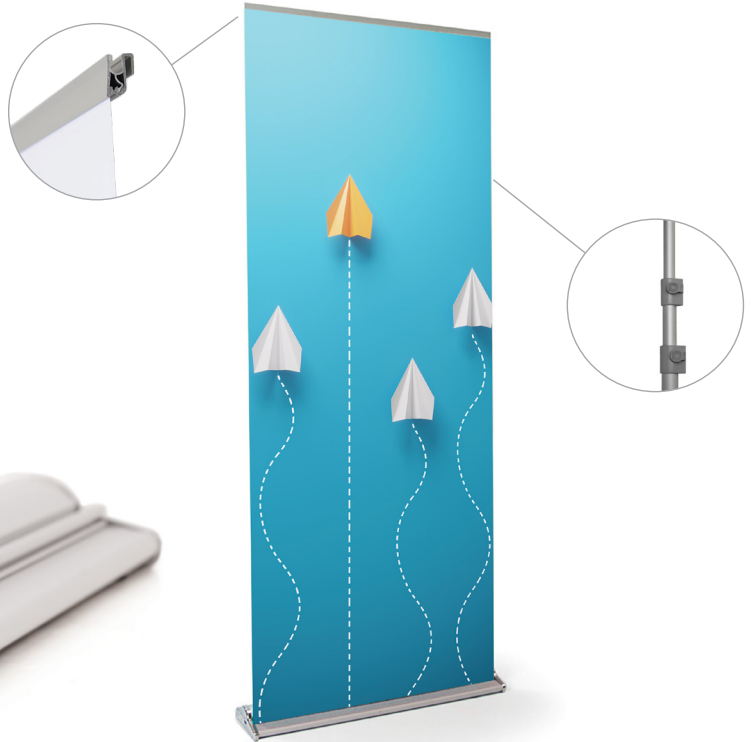
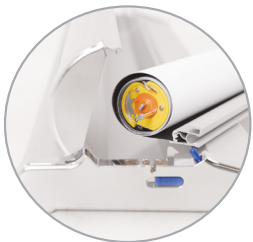

Code	Description	Viewable Area
THE MAJESTIC		
DRMS34	Silver	33.5" W x 33" – 84" H
DRMS39	Silver	39.3" W x 33" – 84" H
DRMS48	Silver	47.25" W x 33" – 84" H
DRMS60	Silver	59" W x 33" – 84" H

Code	Description
ACCESSORIES	
DRAMCS	Magnetic Top Clamp Connector
DRULSL	Universal (UL Listed) LED Light Kit
DRMD34	Interchangeable Graphic Drum (for DRMS34)
DRMD39	Interchangeable Graphic Drum (for DRMS39)
DRMD48	Interchangeable Graphic Drum (for DRMS48)
DRMD60	Interchangeable Graphic Drum (for DRMS60)

(Optional)

Magnetic Top Clamp Connector
DRAMCS

(Optional)

Universal (UL Listed) LED Light Kit
DRULSL



THE AMBASSADOR

- Interchangeable graphic drum
- Manual tension feature
- Adjustable height (allows for use as tabletop display)
- Finish: **Silver**
- Graphic is held with top clamp and bottom clamp drum
- Features adjustable-height pole
- Padded carrying case included

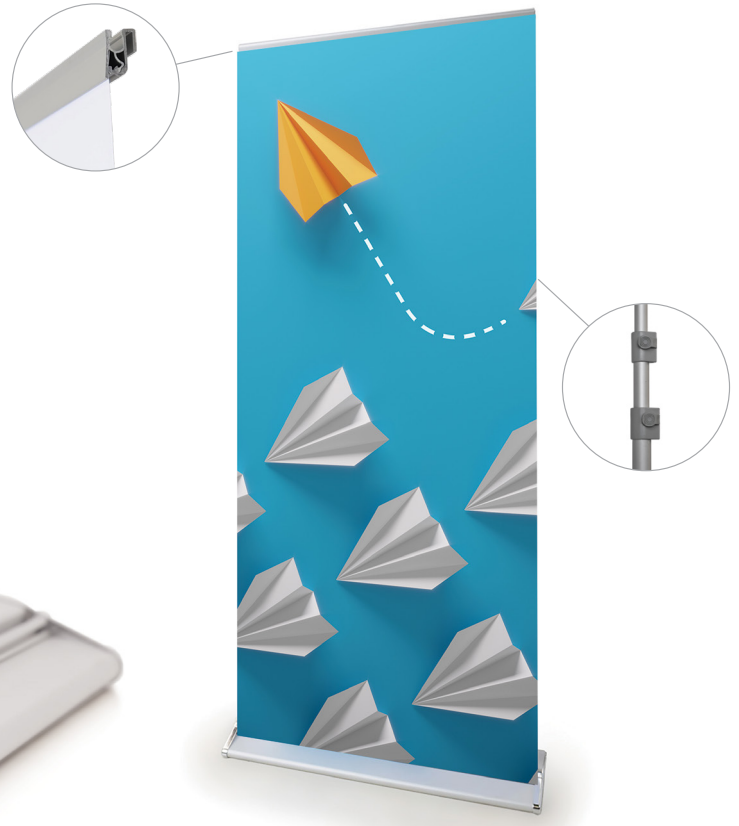

Code	Description	Viewable Area
THE AMBASSADOR		
DRAS34	Silver	33.5" W x 33.5" – 84.5" H

Code	Description
ACCESSORIES	
DRAMCS	Magnetic Top Clamp Connector
DRULSL	Universal (UL Listed) LED Light Kit
DRAD34	Interchangeable Graphic Drum (for DRAS34)

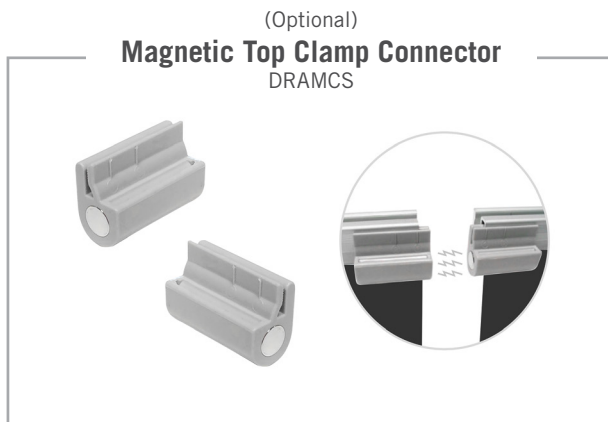



THE LEGACY

- Interchangeable graphic drum
- Angled base design allows graphic edges to touch when multiple stands are sitting next to each other, creating a seamless semi-curved graphic wall
- Graphic is held with a “no-show” top clamp rail and bottom clamp drum
- Finish: **Black**
- Features fixed-height 3-part pole
- Padded carrying case included

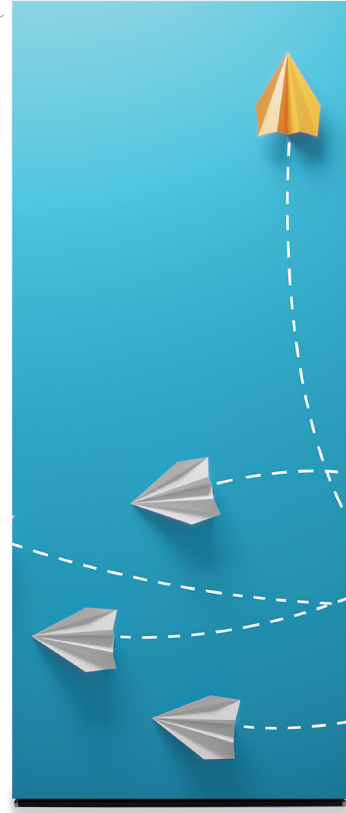
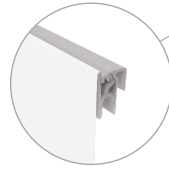

Code	Description	Viewable Area
THE LEGACY		
DRLB34	Black	33.5" W × 85.5" H
DRLB39	Black	39.3" W × 85.5" H

Code	Description
ACCESSORIES	
DRLMCA	Magnetic Top Clamp Connector
DRULSL	Universal (UL Listed) LED Light Kit
DRMD34	Interchangeable Graphic Drum (for DRLB34)
DRMD39	Interchangeable Graphic Drum (for DRLB39)

(Optional)

Magnetic Top Clamp Connector
DRLMCA

(Optional)

Universal (UL Listed) LED Light Kit
DRULSL

UL listed



THE DOUBLE

- Heavy gauge aluminum construction
- Finish: **Silver**
- Graphics are held with top clamp rails and bottom adhesive leader films
- Features fixed-height 3-part pole
- Padded carrying case included

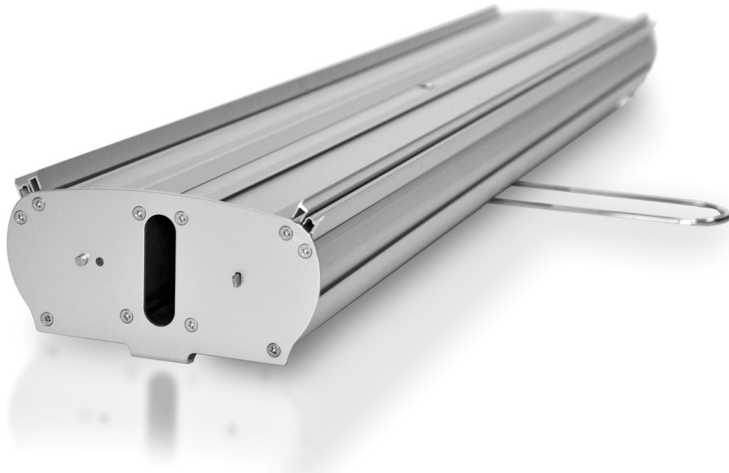

Code	Description	Viewable Area
THE DOUBLE		
DRDS34	Silver	33.5" W x 78.5" H

Code	Description
ACCESSORIES	
DRCMCS	Magnetic Top Clamp Connector <i>Purchase 2 to connect 2 stands together</i>

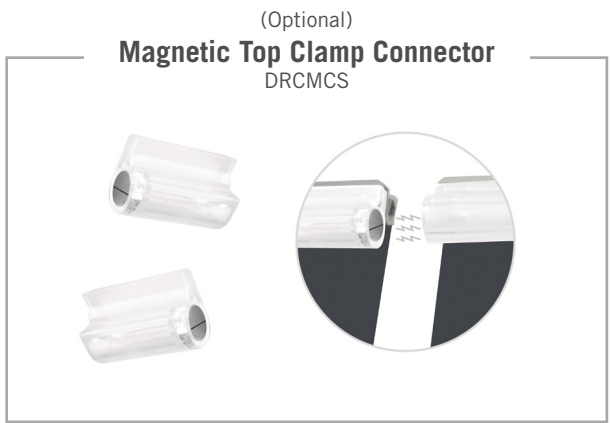



THE NOBLE

- Interchangeable graphic drum
- Finish: **Silver**
- Graphics are held with top clamp rails and bottom clamp drums
- Features fixed-height 3-part pole
- Padded carrying case included



Code	Description	Viewable Area
THE NOBLE		
DRNS34	Silver	33.5" W x 84.5" H

Code	Description
ACCESSORIES	
DRAMCS	Magnetic Top Clamp Connector <i>Purchase 2 to connect 2 stands together</i>
DRMD34	Interchangeable Graphic Drum (for DRNS34)

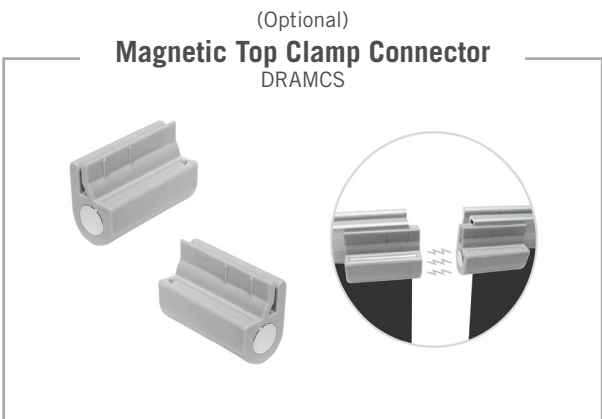



THE SUMMIT II

- Double-sided retractable banner stand
- Removable/fillable base weight with convenient carrying handle
- Finish: **Silver**
- Graphics are held with top clamp rails and bottom adhesive leader films
- Unique extra-secure pole-to-clamp design
- Features adjustable-height pole
- Slide-out stabilizer feet and ground spikes
- Carrying case included



Wind Resistance by Height



40"H - 35 MPH
 50"H - 30 MPH
 60"H - 25 MPH
 70"H - 20 MPH
 80"H - 15 MPH

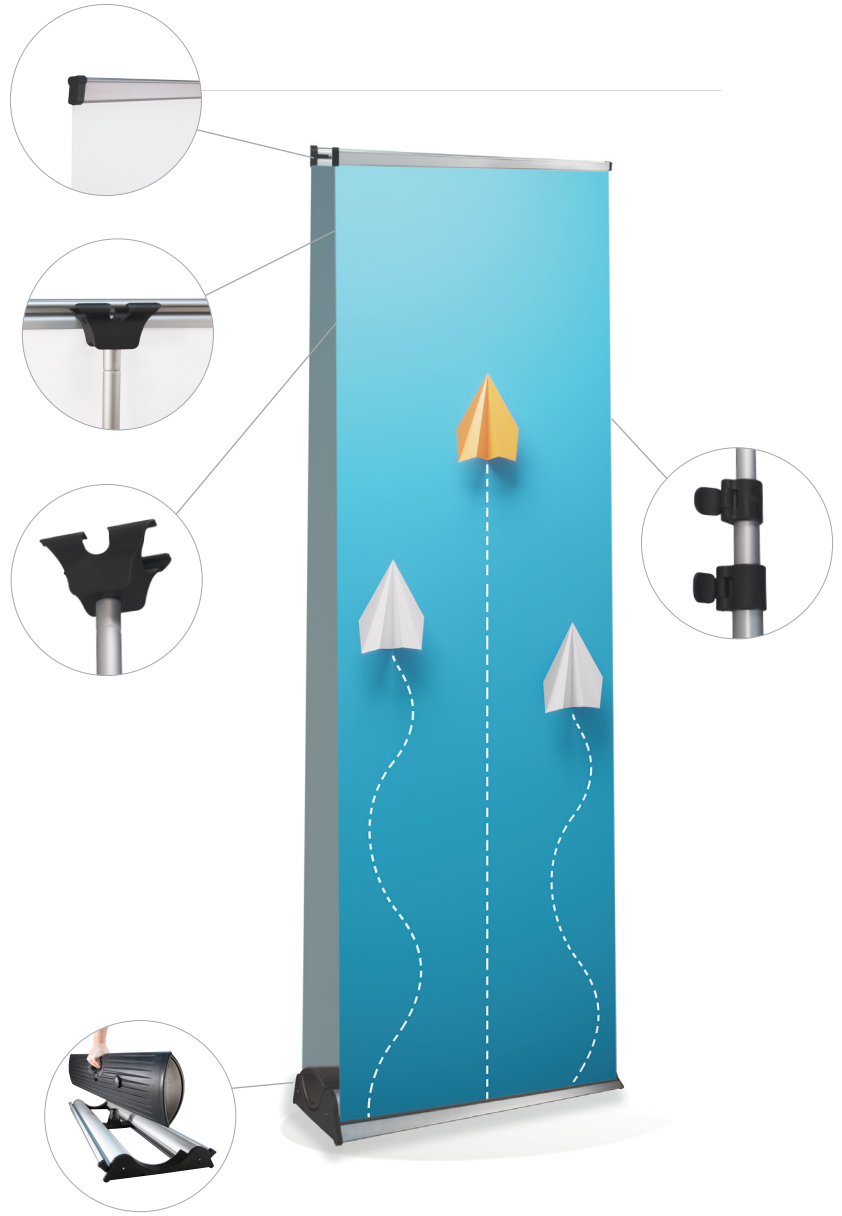

Code	Description	Viewable Area
DRSB34	THE SUMMIT II Silver	33.5" W x 40" - 80" H



POSTER HOLDER

- Fillable wheeled based
- Heavy-duty flex springs help the display to withstand strong winds
- Finish: **Silver**
- Double-sided aluminum Snap-Frame



Code	Description	Viewable Area
	POSTER HOLDER	
DOP2333	Silver	23" W x 32.75" H

Code	Description
	ACCESSORIES
DOPCC2333	Replacement Film Sheet <i>Purchase 2 to replace both sides</i>



PREMIUM L-TENSION

- Adjustable height
- Finish: **Silver**
- Graphic is held with top and bottom clamp rail system
- Carrying case included, with graphic protection tube

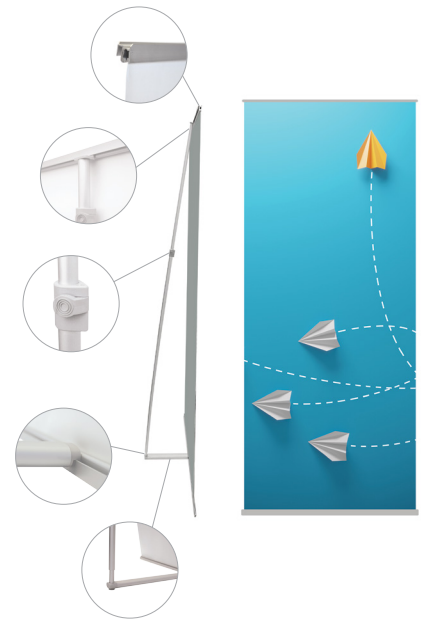
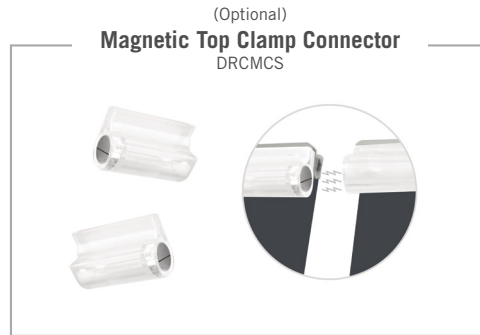

Code	Description	Viewable Area
PREMIUM L-TENSION		
DLS15	Silver	15" W × 20.5" – 33.5" H
DLS24	Silver	23.5" W × 59.5" – 85" H
DLS34	Silver	33.5" W × 59.5" – 85" H

Code	Description
ACCESSORIES	
DRCMCS	Magnetic Top Clamp Connector <i>Purchase 2 to connect 2 stands together</i>

PREMIUM X-TENSION

- Refined aluminum body with fiberglass upright rods
- Quick and easy setup
- Finish: **Silver**
- Carrying bag included (DXS32)



Code	Description	Viewable Area
PREMIUM X-TENSION		
DXS32	Silver	31.5" W × 75" H

↑ SECOND LEVEL



Legacy, pg. 23

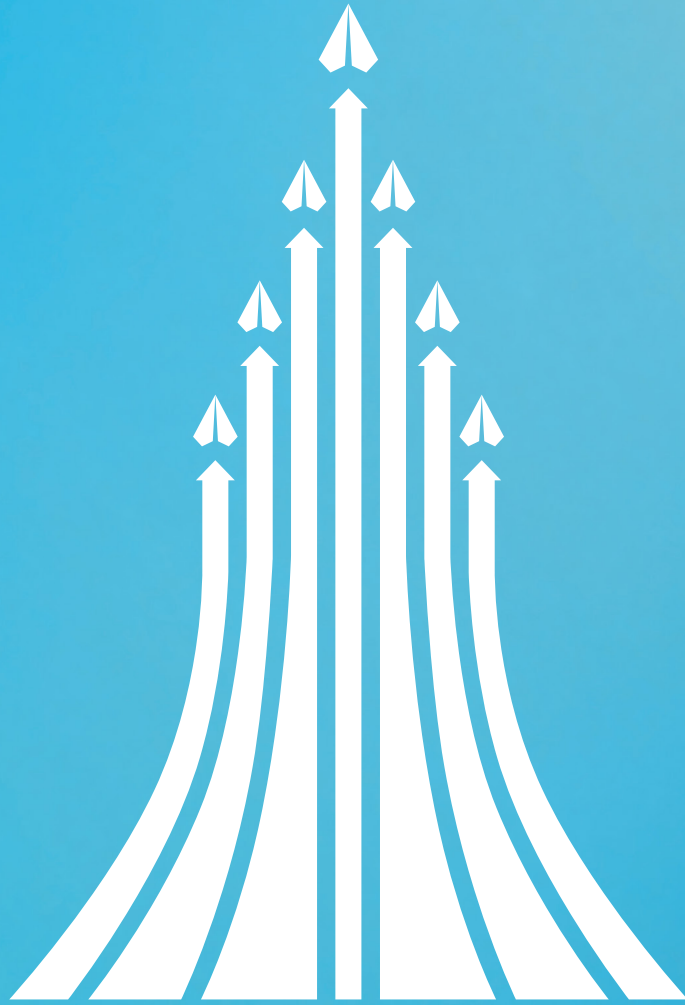

Soar away from the pack.

DISPLAY GUIDE